

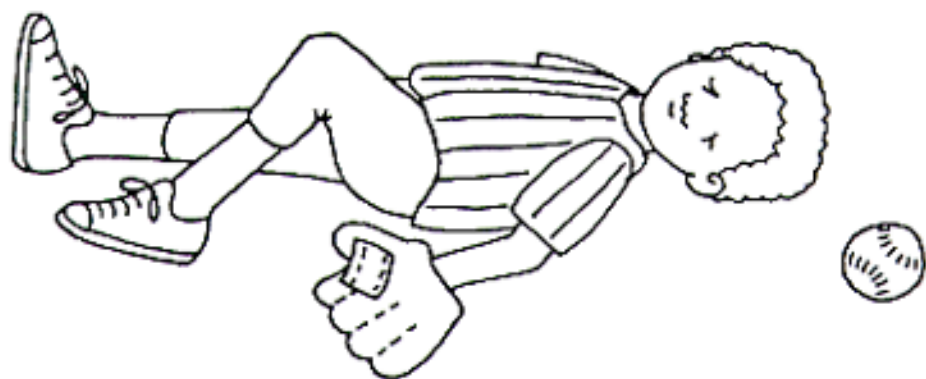

EMS stands for Emergency Medical Service. EMS workers are there if someone is sick or hurt and needs help fast.

Anytime you or someone with you needs help right away, dial 9-1-1.



If someone is injured badly...dial 9-1-1



If someone is choking...dial 9-1-1



If someone swallows poison...dial 9-1-1



If someone is drowning...dial 9-1-1

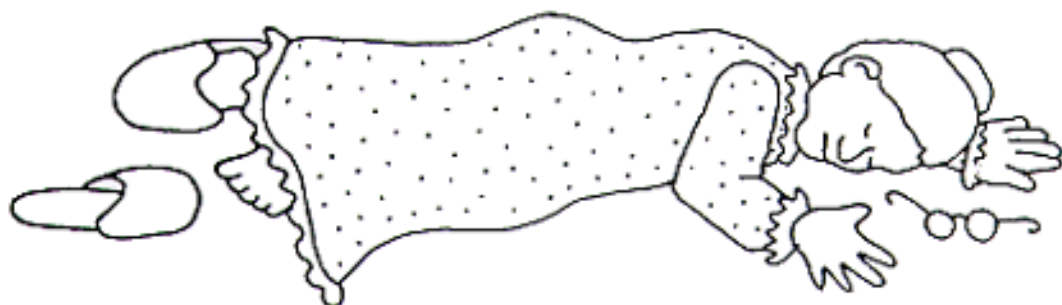

If someone falls and can't get up...dial 9-1-1



I need help!

A line drawing of a woman with long hair, wearing a headband and a sweater, talking on a telephone. She has a speech bubble coming from her mouth that says "I need help!". To her left is a corded telephone base with a numeric keypad.

Just pick up the phone and dial 9-1-1. (Dial 9, then 1, then 1 again.) An operator will answer and get help sent to you right away.

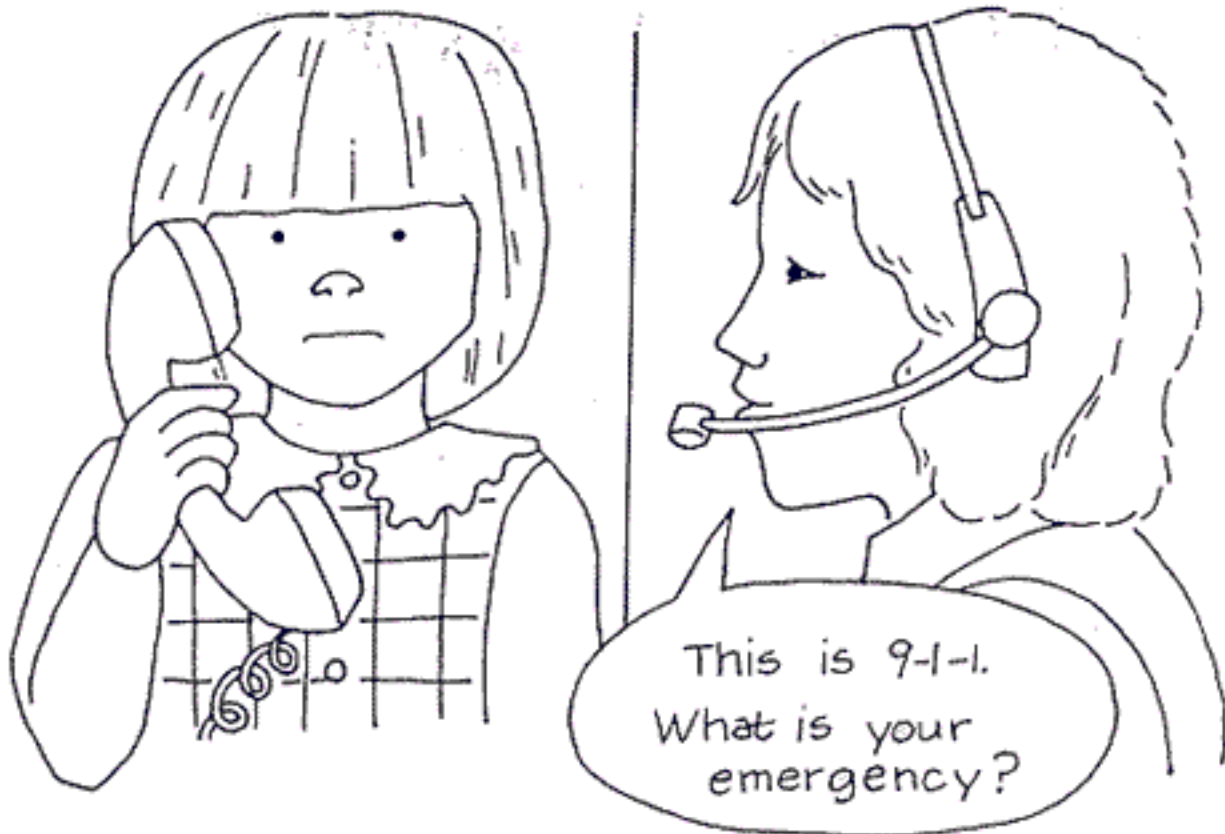

When an emergency happens, stay calm and dial 9-1-1. Here are some things the 9-1-1 operator needs to know:

- (1) What the emergency is.
- (2) Your name.
- (3) The address where you are.
- (4) The phone number where you are.

Don't hang up until the operator tells you to. Wait for the ambulance so you can direct the EMS workers.

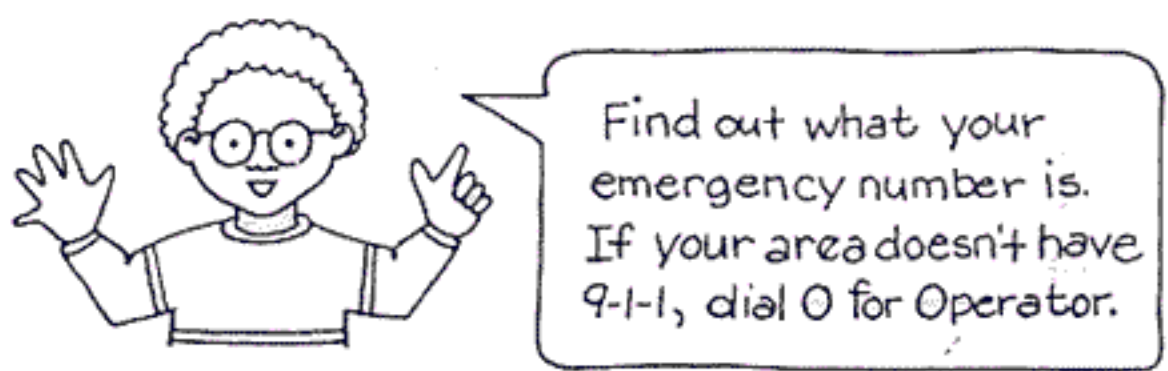

If you are outside, use a pay phone. 9-1-1 is a free call. You do not need to put money in the phone.

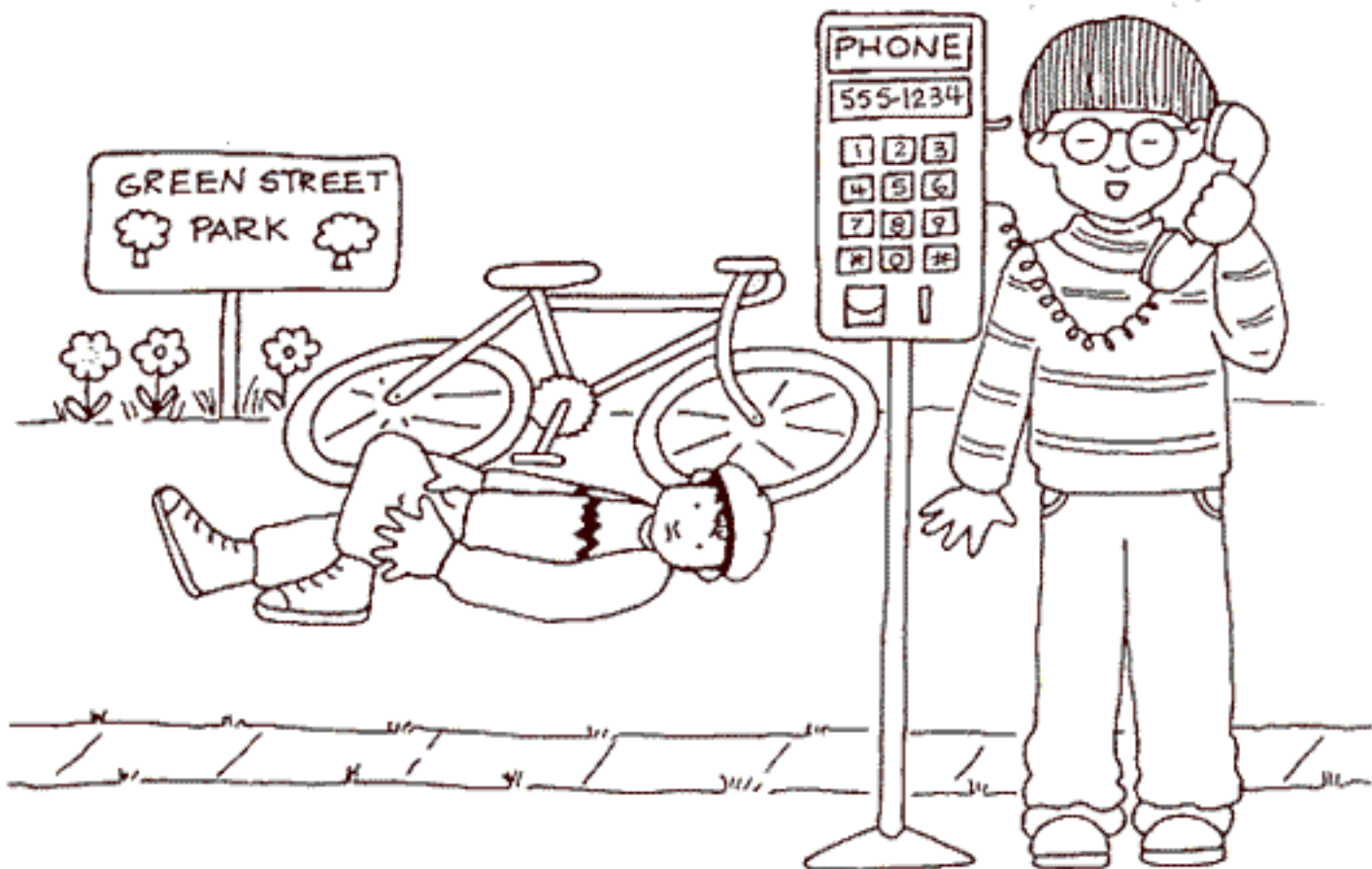

Remember: Just pick up the phone, dial 9, then 1, then 1 again.

ACTIVITY: Ken Brown and his friend Carlos were riding their bikes in Green Street Park. Carlos hit a rock and fell off his bike. He was hurt badly. Ken ran to a pay phone and dialed 9-1-1.

Use clues in the picture on this page to write what Ken should tell the 9-1-1 operator.

The emergency is _____

I am at _____

My name is _____

The phone number I'm calling from is _____

The emergency is at _____

If an ambulance is needed, your 9-1-1 operator will call the EMS team.

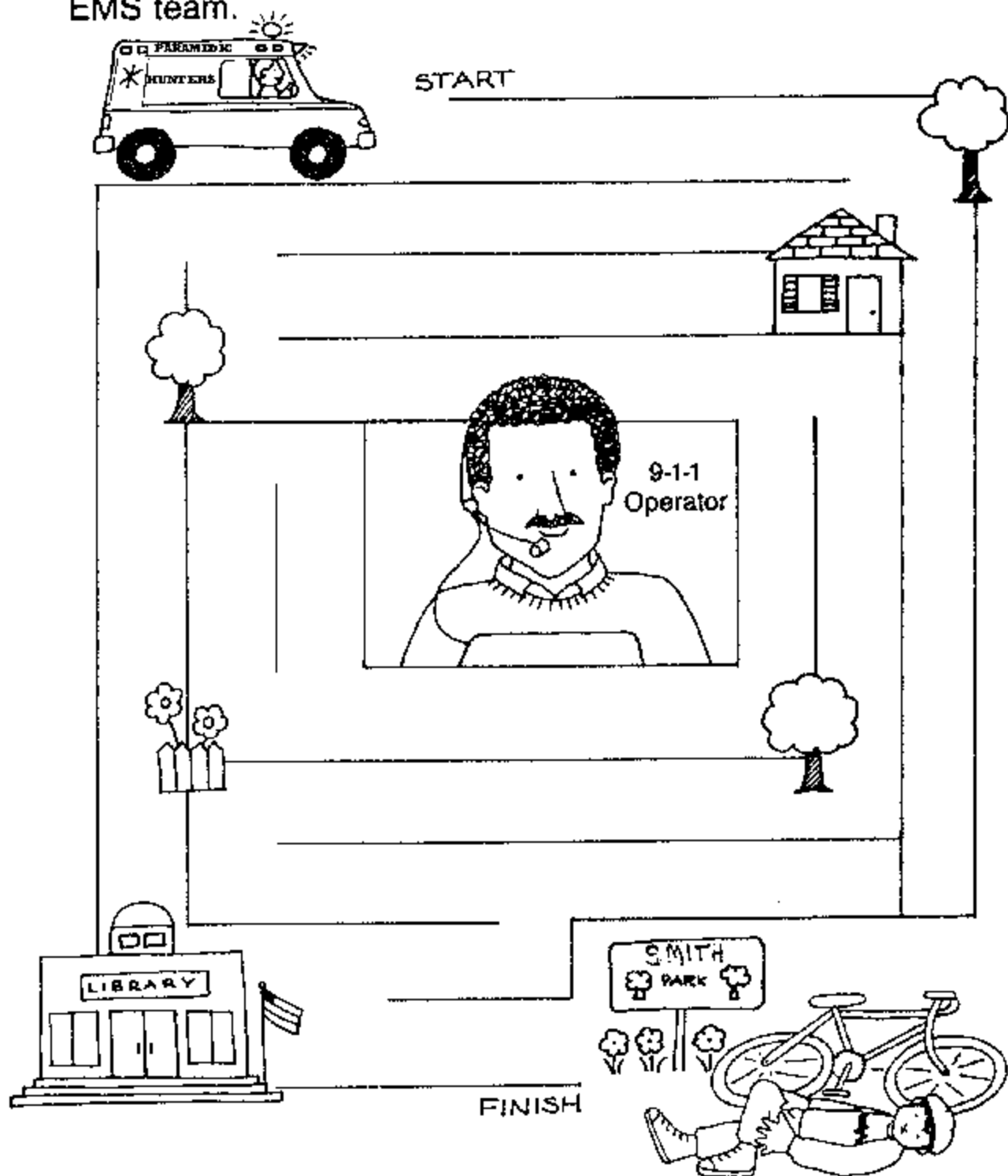

ACTIVITY: Help the ambulance get to the accident fast!

Answer on page 16

The sirens and flashing lights let everyone know that help is on the way! Other drivers pull over so the ambulance can get by.

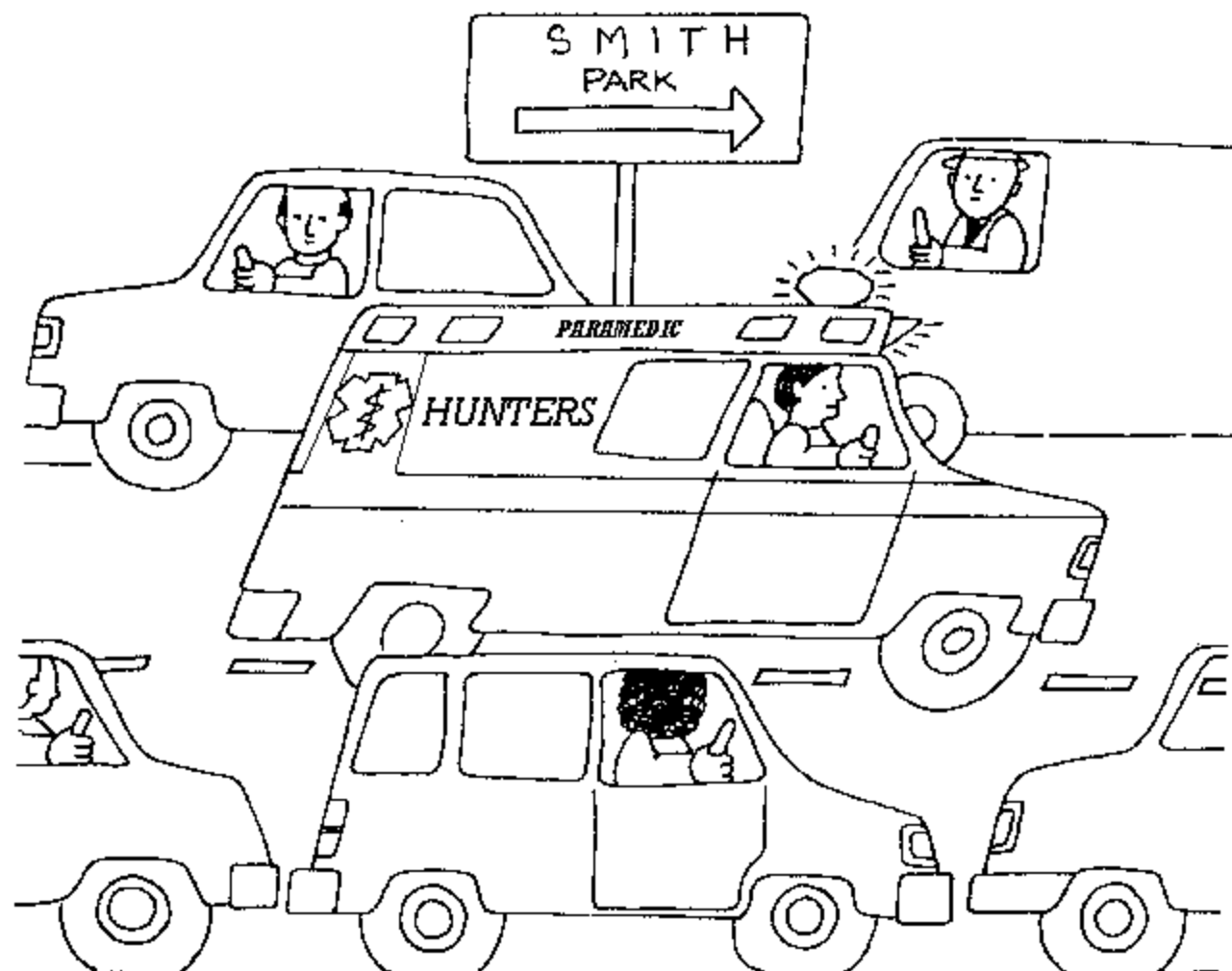

Getting first aid fast saves lives! Hunter's ambulance has many special things that EMS workers use to help people even before they get to the hospital.

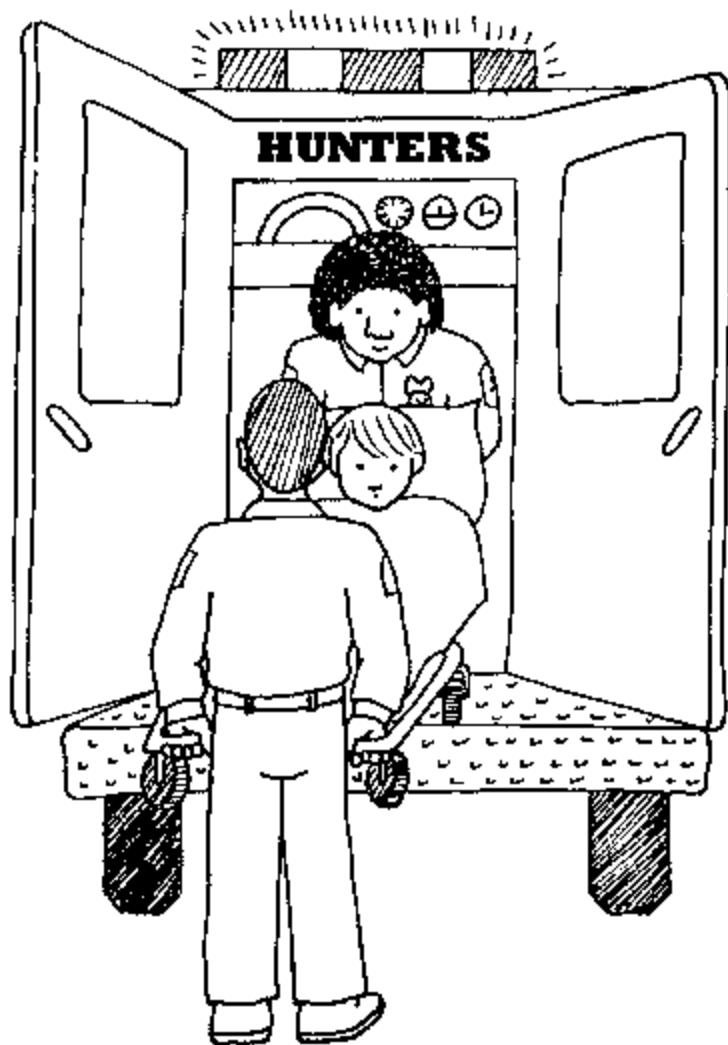

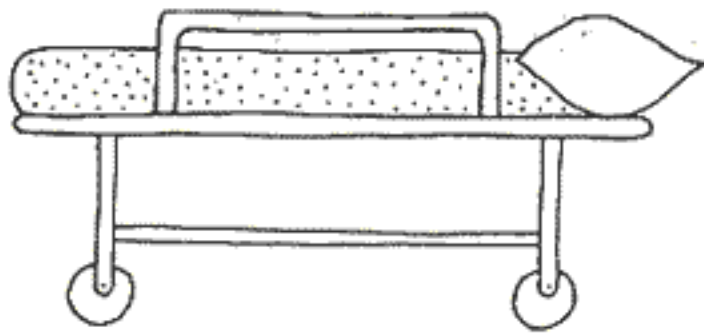

STRETCHER

Helps EMS workers load patients into the ambulance. It can be raised or lowered.

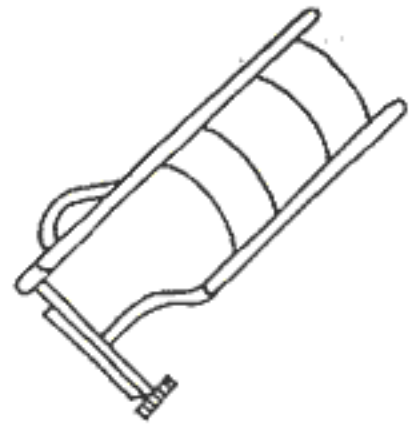

SPLINTS

Help EMS workers keep injured arms and legs still so they won't hurt.

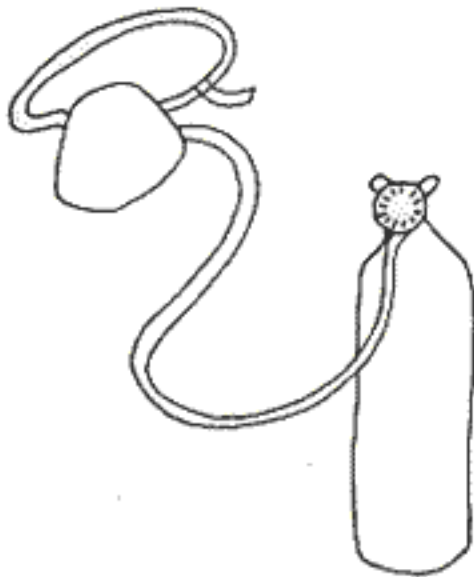

OXYGEN MASK

Helps EMS workers give oxygen to people who are having trouble breathing.



CUFFS

Help EMS workers check blood pressure.



STETHOSCOPE

Helps EMS workers hear a person's heartbeat and check their heart.

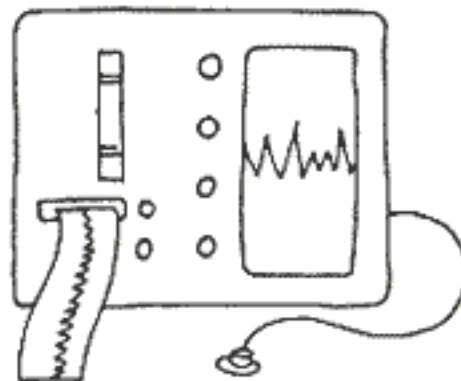

HEART MONITOR

Helps EMS workers see patient's heartbeat.

Emergency medical workers get special training. Emergency Medical Technicians (EMTs) and Paramedics are trained to give first aid. Paramedics are also trained to give medicine to make you feel better or even save a life.

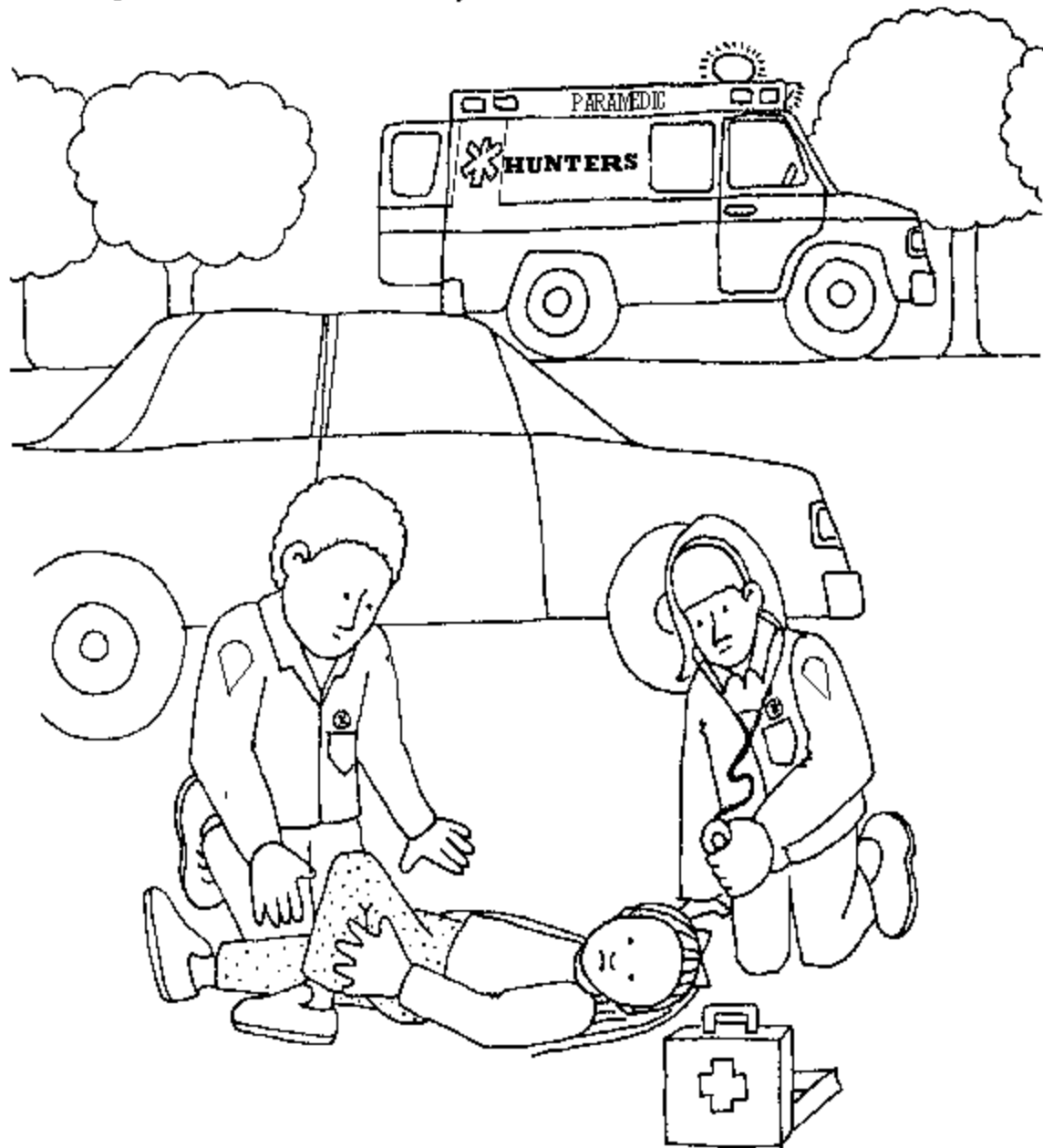

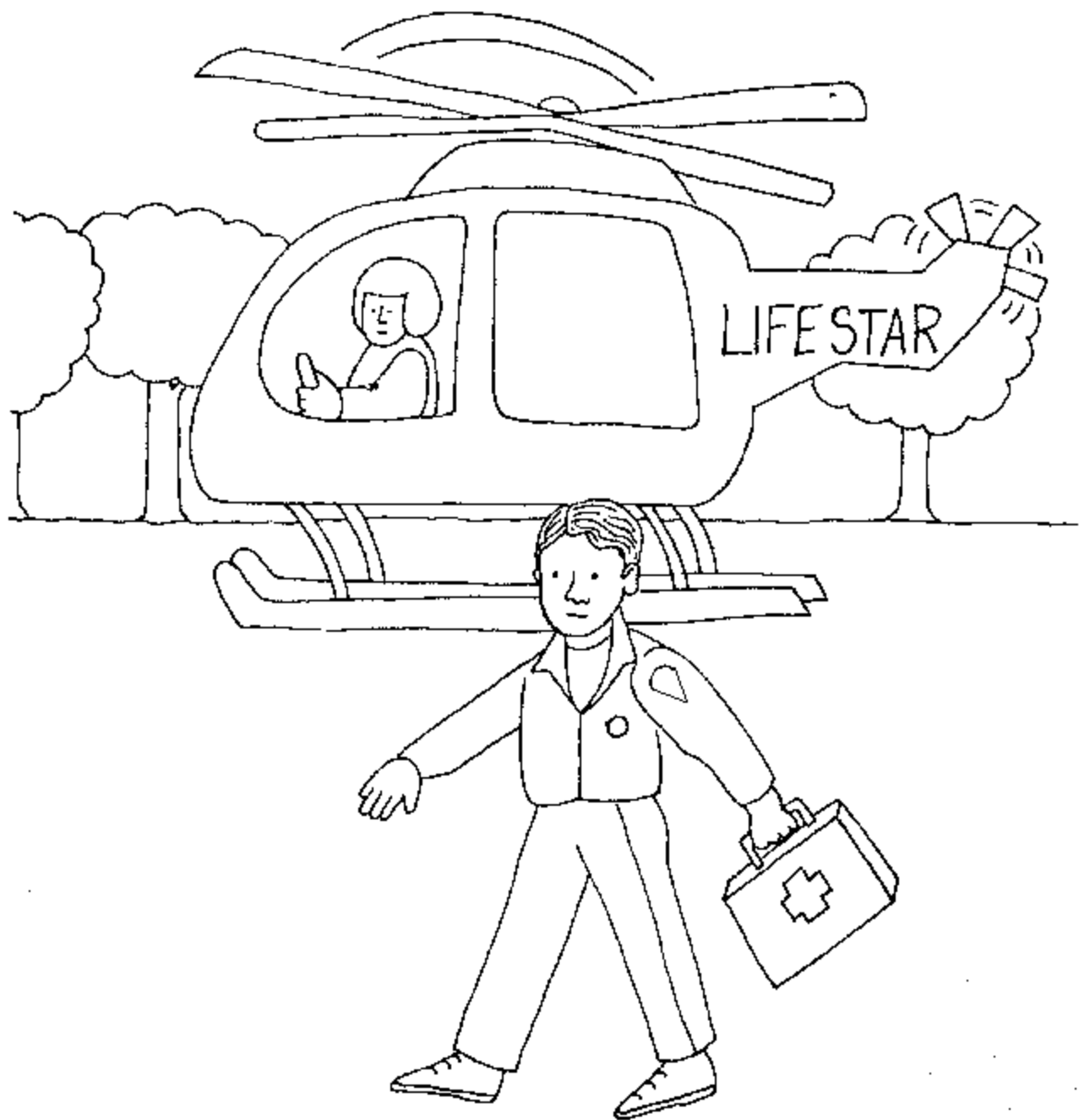

EMS workers also come by helicopters or “air ambulances.” Helicopters can quickly take people to hospitals where they can get special treatment.

Helicopters are used to rescue people from places that regular ambulances can't get to.



ACTIVITY: Connect the dots to find out where this "air ambulance" has gone to help an injured person!

Firefighters are trained to give first aid and often work together with EMS workers.

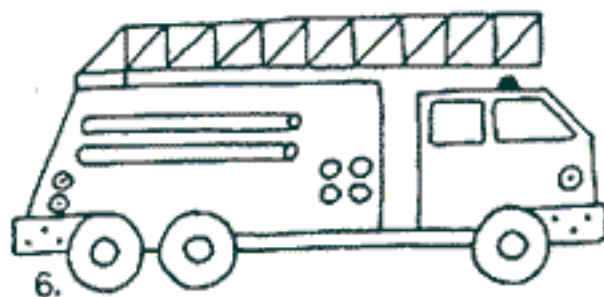
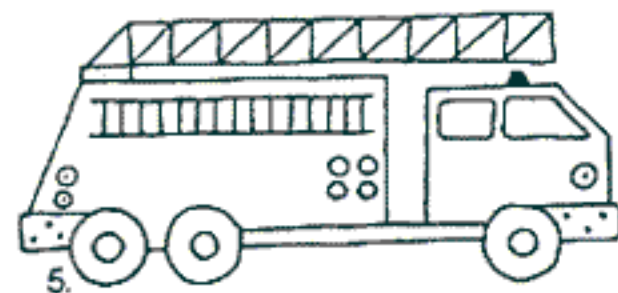
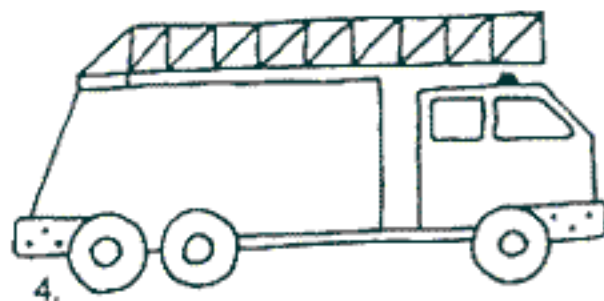
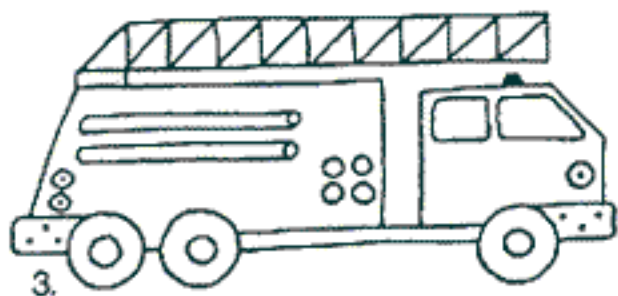
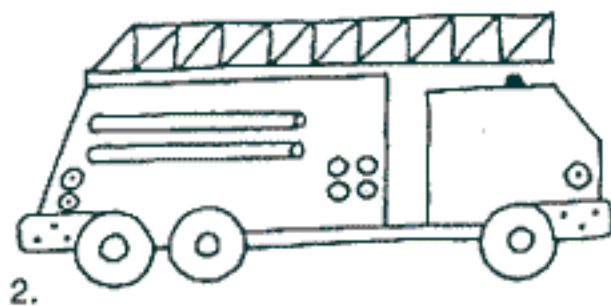
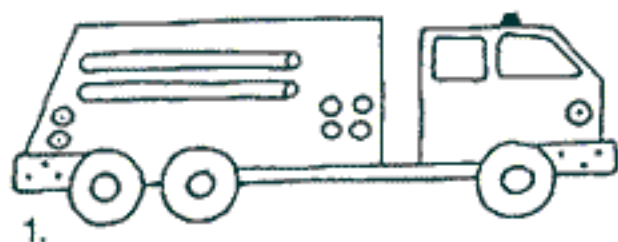

ACTIVITY: Find the two fire engines that are the same.

In many places, police officers are trained to give first aid. If they arrive first, they can help until the ambulance comes.



An EMT radios ahead as the ambulance rushes to the emergency room. He or she tells the EMS workers at the hospital what kind of help is needed.

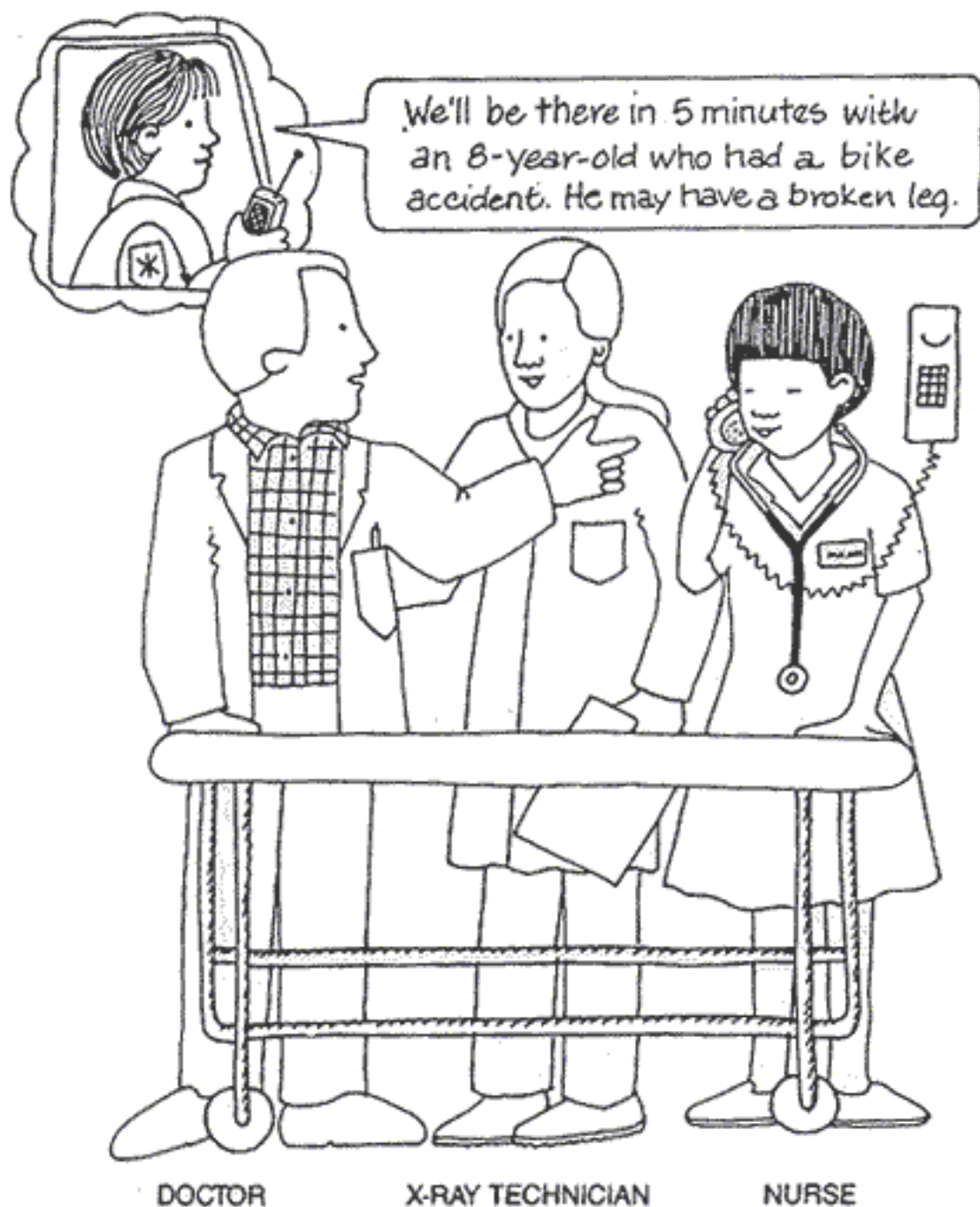

These hospital EMS workers are ready to help in the emergency room.

We are glad we can count on the EMS workers!



Page 6

ANSWERS

Page 5. The emergency is: My friend fell off his bike and is hurt
I am at: Green Street Park
My name is: Ken Brown
The phone number I'm calling from is: 555-1234
The emergency is at: Green Street Park

Page 13. Fire engines 3 and 6 are the same

